



# Blank Metallbau-Technik

| seit 1964

Unternehmensbroschüre  
Company brochure



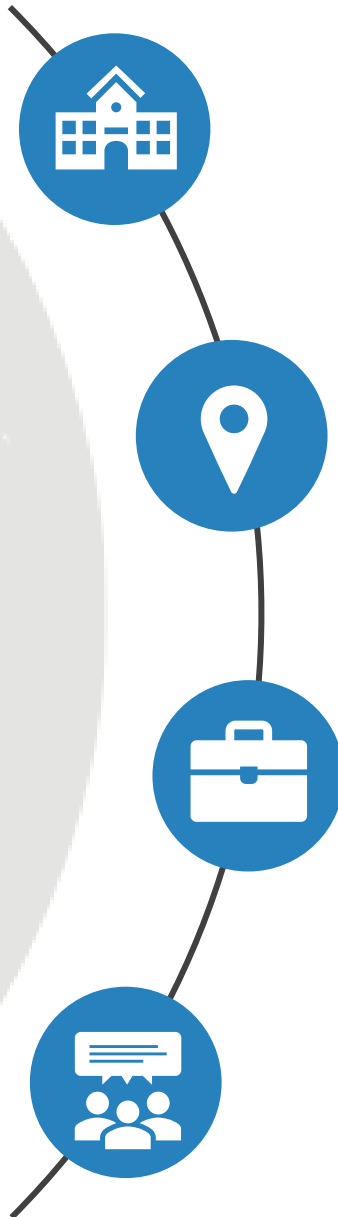

## Unternehmen Company

Unternehmensprofil  
Kernkompetenzen  
Company profile  
Core competences

## Standorte Locations

Übersicht  
Overview

## Portfolio Portfolio

Produkte  
Zertifikate  
Products  
Certificates

## Referenzen References

Kunden  
Kontaktinformationen  
Customers  
Contact information

# Unternehmensprofil Company



Die Firma **Blank Metallbau-Technik GmbH**, mit Sitz in Holzgerlingen, ist als mittelständisches Unternehmen seit 1964 im **Stahl-, Metall- und Aluminiumbau** und deren weltweiten **Montage** tätig.

Wir sind spezialisiert auf die Erstellung kundenspezifischer Schutzgitteranlagen aus Aluminium und Stahl, sowie Anlagenkomponenten, wie Robotersockel, Beladestellen, Drehtische, Anlagenmontage, Tore, Türen und vieles mehr.

Wir planen, konstruieren und fertigen Ihre Projekte im Groß- und Kleinstahlbau mit abschließender Endmontage vor Ort.



The company **Blank Metallbau-Technik GmbH**, based in Holzgerlingen, has been active as a medium-sized enterprise in **steel, metal, and aluminum construction** and their worldwide assembly since 1964.

We specialize in the production of **customer-specific protective grid systems** made of aluminum and steel, as well as system components such as **robot bases, loading stations, turntables, system assembly, gates, doors**, and much more.

We plan, design, and manufacture your projects in both large and small-scale steel construction, with **final assembly on-site**.



# Kernkompetenzen

## Competences



Wir sind in der Lage, durch die komplette Abwicklung unserer Kundenprojekte von der **Entwicklung, Konstruktion, Fertigung, Bearbeitung** bis zur **Logistik** und weltweiter **Montage**, auf spezielle Anforderungen schnell, umfassend und flexibel zu reagieren. Daher können wir auf ein umfangreiches **Erfahrungspotenzial** zurückgreifen. Dieses Wissen setzen wir ein, um unseren Kunden eine individuelle und **passende Gesamtlösung** anzubieten.

Unsere **qualifizierten Projektteams** begleiten und betreuen Kundenprojekte von der Planung bis zur Endmontage vor Ort.

### Unser Service:

Wir sind in allen Planungs- und Fertigungsschritten jederzeit ihr **direkter Ansprechpartner!**



We are able to **respond quickly**, comprehensively, and flexibly to specific requirements by handling the complete processing of our customer projects, **from development, design, manufacturing, processing, logistics, to worldwide assembly**. Therefore, we can draw on extensive experience and use this knowledge to offer our customers an individual and appropriate overall solution.

Our **qualified project teams** accompany and support customer projects from planning to final on-site assembly.

### Our service:

We are your **direct contact** at all planning and manufacturing stages!

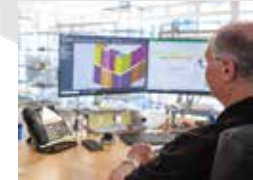

Konstruktion/Entwicklung  
Construction/Development



Messtechnik  
Measurement



Logistik  
Logistics



CNC-Bearbeitung  
CNC processing



Montage  
Assembly

# Produktionsstandorte

## Production sites



**Produktionsstandort I, Max-Eyth-Str. 7-9**  
Verwaltung, Konstruktion/Entwicklung, Projekt  
Vormontage, Lackierung, Stahlfertigung I, Kunststoffe

**Production site I, Max-Eyth-Str. 7-9**  
Administration, construction / development, project,  
pre-assembly, painting, steel fabrication I, plastics



**Produktionsstandort II, Daimlerstr. 10**  
Stahlfertigung II

**Production site II, Daimlerstr. 10**  
Steel production II



**Produktionsstandort III, Max-Eyth-Str. 16**  
CNC-Bearbeitung, Profilverfahren, Lack

**Production site III, Max-Eyth-Str. 16**  
CNC-Machining, profile technique, paint



**Produktionsstandort IV, Max-Eyth-Str. 26**  
Aluminiumfertigung

**Production site IV, Max-Eyth-Str. 26**  
Aluminum fabrication



**Produktionsstandort V, Max-Eyth-Str. 14**  
Produktions- und Montagehalle

**Production site V, Max-Eyth-Str. 14**  
Production and assembly hall

# Produkte und Leistungen

## Products and services



### Ein Auszug aus unserem Produkt- und Leistungsangebot:

- Klein- und Großstahlbau inkl. Montage
- Schutzzäune Alu / Stahl in diversen Variationen und Anforderungen
- Robotersockel fertigen und montieren
- Fundamentplatten fertigen und montieren
- Beladestellen / Doppelstock-Beladestellen fertigen und montieren
- Alu / Stahl Schubladen fertigen und montieren
- Alu / Stahl Hubtore fertigen und montieren
- IR Gestelle fertigen und montieren
- Sämtlich Regale wie bspw. Durchschubregal fertigen und montieren
- Erstellung von Portalen mit Absturzsicherung mit anschließender Montage
- Produktion von Bereichstrennungen mit Montage
- Herstellung von Lichtschrankenhalter und Montage
- Fertigung und Montage von diversen Anlagenkomponenten
- Fertigung und Montage von Drehtischen



### An excerpt from our range of products and services:

- Small and large steel construction including assembly
- Protective fences made of aluminum/steel in various designs and requirements
- Manufacturing and assembly of robot bases
- Manufacturing and assembly of foundation plates
- Manufacturing and assembly of loading stations/double-decker loading stations
- Manufacturing and assembly of aluminum/steel drawers
- Manufacturing and assembly of aluminum/steel lifting gates
- Manufacturing and assembly of IR frames
- Manufacturing and assembly of various shelves, such as pass-through shelves
- Creation of portals with fall protection and subsequent assembly
- Production of area separations with assembly
- Manufacturing of light barrier holders and assembly
- Manufacturing and assembly of various system components
- Manufacturing and assembly of turntables.

- Fertigung von diversen Pendelklappen mit Montage
- Konstruktion und Fertigung von Werkerpodesten, Bühnen, Ausbauschiene und sonstigen Stahlbauten inkl. Montage
- Untergestelle für 7.-Achse fertigen und montieren
- Montage von Heberaufzügen inkl. Wartungspodesten
- Grobmontage von kompletten Anlagen
- Herstellung von Trägerwagen, Sackbahnhöfen und Logistikbahnhöfen inkl. Montage
- Erstellung von Anfahrschutze / Leitplanken mit Montage
- Fertigung und Montage von Doppelboden
- Lieferung und Montage von verschiedenen Abhängungen wie bspw. Schweißschutzvorhängen, Spritzschutz, etc.
- Fertigung von Kabinen für Messstationen mit Montage
- Herstellung von Galgen und Klebeständer mit Montage
- Lieferung und Montage von verschiedenen Ständern: Ständer für Werkzeugbahnhof, Referenzständer, Messspitzenständer, etc.
- Fertigung und Montage von Laufstegen

- Manufacturing of various pendulum flaps with assembly
- Design and manufacturing of worker platforms, stages, expansion rails, and other steel constructions including assembly
- Manufacturing and assembly of underframes for 7th axis
- Assembly of lifting elevators including maintenance platforms
- Rough assembly of complete systems
- Production of carrier wagons, sack stations, and logistics stations incl. assembly
- Creation of impact protection / guardrails with assembly
- Manufacturing and assembly of raised floors
- Delivery and assembly of various suspensions, such as welding protection curtains, splash guards, etc.
- Manufacturing of cabins for measuring stations with assembly
- Production of booms and adhesive stands with assembly
- Delivery and assembly of various stands: stands for tool stations, reference stands, measuring tip stands, etc.
- Manufacturing and assembly of walkways.

# Stahl- und Metallbau

## Steel and metal construction



Wir realisieren und montieren weltweit **Klein- und Großstahlbauten**.



We realize and assemble **small and large steel structures** worldwide.



# Schutzzäune

## Protective fences



Unsere Schutzzäune fertigen wir aus **Aluminium** oder **Stahl** in verschiedenen Ausführungen.



Made of aluminum and steel in various designs.

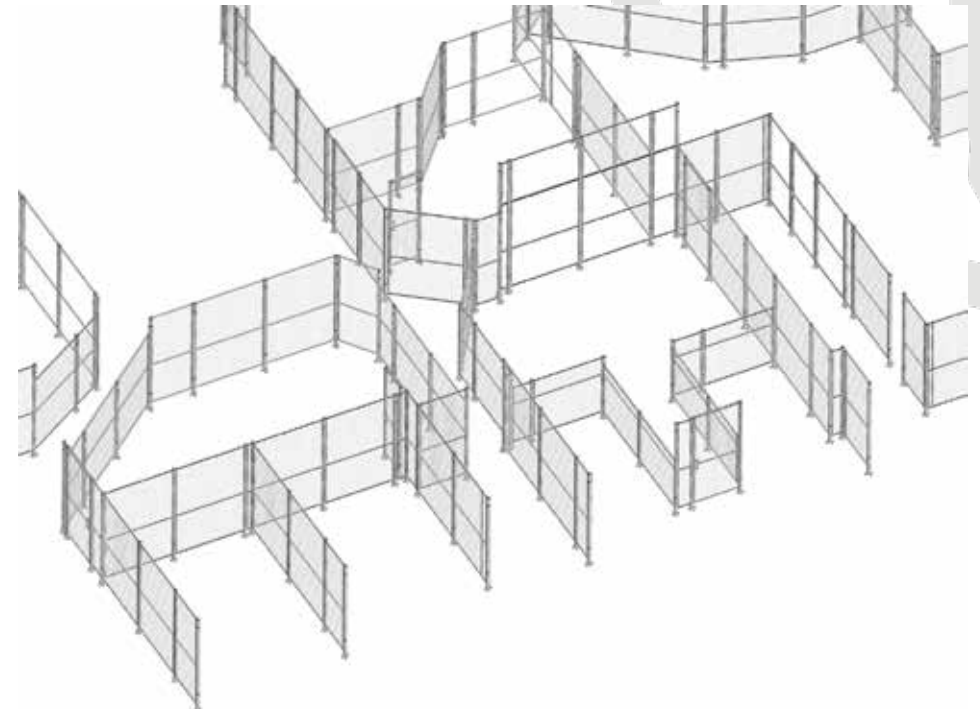



# Blank EcoSteel Schutzzaun

## Blank EcoSteel protective fence



Dieser Schutzzaun ist aus Stahl gefertigt mit einem **hohen Sicherheitsstandard** und vielen Komponenten. Er hält einer Belastung nach Pendelversuch laut **DIN EN ISO 1420:2016-05** von **1.950 Joule** stand und übertrifft deutlich die geltenden Anforderungen der Industrie von 1.550 Joule.

### Dieses System überzeugt durch:

- einen hohen Sicherheitsstandard
- einfache Montage
- hochwertige Qualität

Die einzelnen Elemente, wie Zaunfelder, Pfosten und Türen sind in verschiedenen Breiten, Höhen, Farben und Ausführungen erhältlich.



This protective fence is made of steel with a high safety standard and numerous components. It withstands a pendulum impact test according to **DIN EN ISO 1420:2016-05** with a force of **1,950 joules**, significantly surpassing the industry's current requirement of 1,550 joules.

### This system convinces with:

- a high level of safety
- easy installation
- high-quality craftsmanship

The individual components, such as fence panels, posts, and doors, are available in various widths, heights, colors, and designs.



# Flächen- und Fangschutz

## Area and catch protection

 Dienen als trennende **Schutzeinrichtung** in Lager- und Produktionshallen, um Personen vor Gefahren und Unfällen zu schützen. **Fertigung** und **Vor-Ort-Montage** durch unsere qualifizierten Mitarbeiter.

 They serve as **separating safety devices** in warehouses and production halls to protect people from hazards and accidents. **Manufacturing** and **on-site installation** by our qualified employees.



# Industriebühnen

## Industrial platforms

 Wir **konstruieren, fertigen** und **montieren Industriebühnen** nach Maß. Diese Bühnen ermöglichen den Zugang zu höheren Ebenen in einer Halle. Die Nutzflächenauslastung kann man somit erheblich erhöhen oder Zugänge für Wartungs- oder Reparaturarbeiten an großen Maschinen schaffen.

 We **design, manufacture, and install customized industrial platforms** or mezzanines. These platforms provide access to higher levels within a hall, allowing for a significant increase in usable floor space or creating access for maintenance or repair work on large machines.



# Treppen und Steigleitern

## Stairs and Ladders

 **Konstruktion, Fertigung** und **Montage** mit verschiedensten Anforderungen.

 **Design, manufacturing,** and **installation** with various requirements.



# Laufstege Walkways



Konstruktion Fertigung und Montage von **Lauf- und Wartungsstegen** an einem Klärwerk.



Design, manufacturing, and installation of **walkways and maintenance platforms** in a wastewater treatment plant.



# Werkerpodeste

## Worker platforms

 Wir bieten die **Konstruktion, Fertigung und Vor-Ort-Montage** an. Diese Podeste kommen bei Fertigungsstraßen zum Begehen von Mitarbeiter zum Einsatz. Sie gewährleisten ein ergonomisches und wirtschaftliches Arbeiten. Durch unseren **Stahlbau** können die **Werkerpodeste** flexibel an die räumlichen Gegebenheiten angepasst werden. Der Bodenbelag kann entweder aus Holz oder Aluminium gefertigt werden.

 We offer **design, manufacturing, and on-site installation services** for worker platforms. These platforms are used in production lines for employees to walk on, ensuring ergonomic and efficient work. Our **steel construction** allows the **worker platforms** to be flexible and adaptable to spatial requirements. The flooring can be made of either wood or aluminum.



# Bereichstrennungen

## Area partitions



Fertigung und Montage in verschiedenen vollflächigen oder Gitterausführungen z. B. für den Maschinenschutzbereich.



Manufacturing and installation of various full-surface or grid designs, e.g. for the machine protection area.



# Schweißschutz, Spritzschutz

## Welding and splash protection

 Lieferung und Montage von **Schweißschutzkabinen und -abtrennungen** für ein sicheres Arbeiten bei Funkenflug und Hitze. Schweißschutzvorhänge und Schweißschutzplatten nach **DIN 1598** sind in verschiedenen Dicken und Farben, sowie in **Brandschutzklasse B1** erhältlich.

 Delivery and installation of **welding protection cabins and enclosures** for safe work during sparks and heat. Welding protection curtains and plates according to **DIN 1598** are available in various thicknesses and colors, as well as in **fire protection class B1**.





# Kabinen

## Cabins



**Fertigung** und **Montage** von **Kabinen** mit verschiedenen Funktionen z. B. für Messstationen.



**Manufacturing** and **installation** of **cabins** with various functions, for example, for measuring stations.



# Robotersockel

## Robot bases

 Wir fertigen und montieren **Roboterpodeste** je nach Bedarf in den unterschiedlichsten Höhen um den Arbeitsbereich optimal zu gestalten zu können. Somit wird eine gute Zugänglichkeit in den Fertigungsbereichen gewährleistet.

 We manufacture and install **robot platforms** according to specific needs at various heights in order to optimize the work-space. This ensures good accessibility in manufacturing areas.



# Drehtische

## Rotary tables

 Wir fertigen und montieren **Drehtische** u. a. für die automotivie Industrie. Drehtische übernehmen komplexe Arbeitsabläufe in dem sie im gewünschten Takt von der **Einlegestation** zur **Bearbeitungsposition** bis zur **Entnahmestation** rotieren.

 We manufacture and install **turntables** e. g. for the automotivie industry. Turntables perform complex work processes by rotating from the **loading station** to the **processing position** and finally to the **unloading station** at the desired pace.

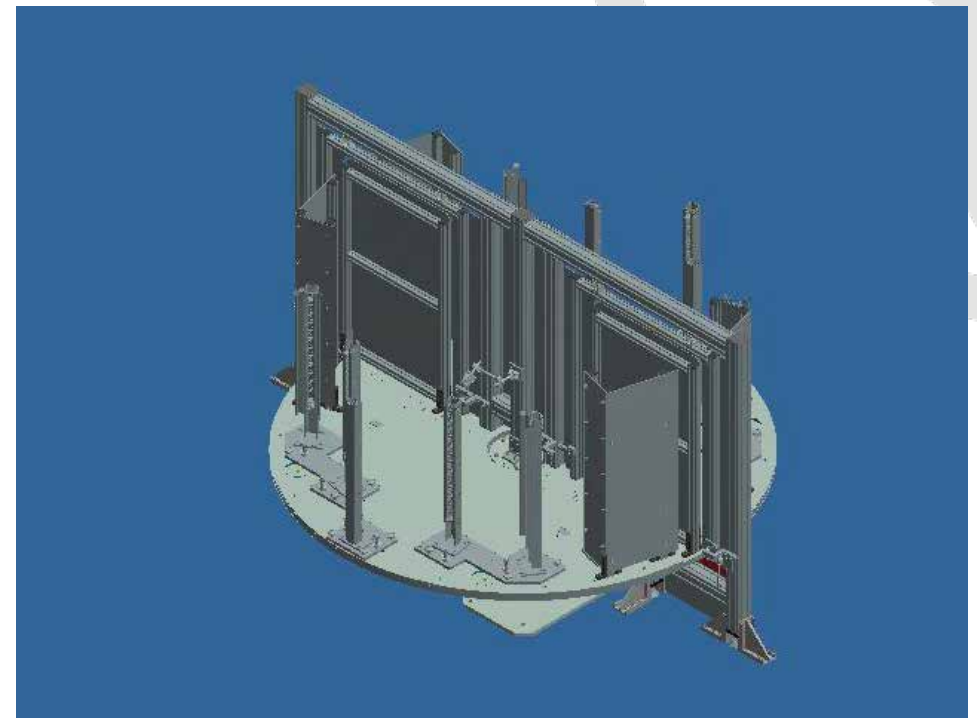
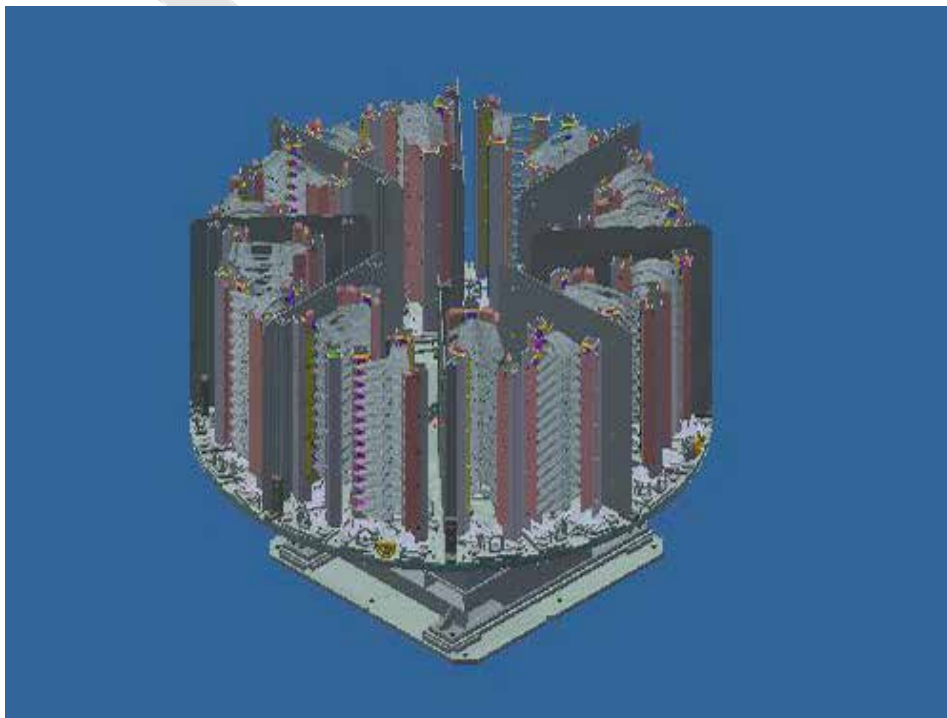

# 7. Achse Untergestelle

## 7th axis underframes

 **7. Achse Untergestelle** für Roboter fertigen und montieren wir nach Kundenwunsch. Die **7. Achse** erweitert den Aktionsradius des Roboters erheblich und dadurch ist er flexibler im Einsatzbereich, wie z. B. bei Pick-and-Place-Anwendungen.

 We manufacture and install **7th axis frames** for robots according to customer requirements. The **7th axis** significantly expands the robot's operating range and makes it more flexible in its applications, such as in pick-and-place operations.

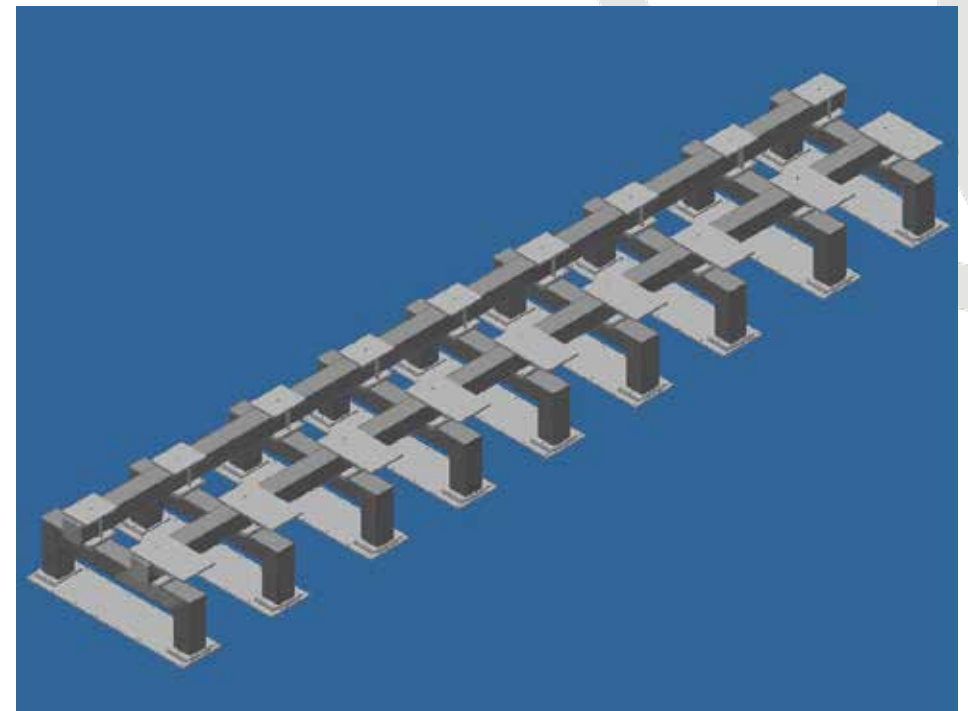

# Beladestellen / Doppelstock-Beladestellen

## Loading stations / double-deck loading stations



Fertigung und Montage





Manufacturing and assembling



# Ladungsträger

## Load carriers

 **Ladungsträger** werden von Robotern befüllt und wenn der Ladungsträger voll bestückt ist wechselt er zum nächsten. Wir **fertigen** und **montieren** individuell nach Vorgabe solche Ladungsträger für z. B. Palettierungsaufgaben.

 **Loading carriers** are filled by robots and when the loading carrier is fully stocked, it switches to the next one. We **manufacture** and **install** such loading carriers individually according to specifications for palletizing tasks, for example.



# Hubtore aus Aluminium oder Stahl

## Aluminum or steel lifting gates

 **Hubtore** besitzen ein festes und platzsparendes Torblatt, das senkrecht nach oben öffnet. Wir fertigen **pneumatische, elektrische** und **mechanische Hubtore** für den Personenschutz, sowie taktbezogene Hubtore im Produktionsprozess.

 **Vertical-lifting sectional doors** have a fixed and space-saving door panel that opens vertically upwards. We manufacture **pneumatic, electric, and mechanical vertical-lifting sectional doors** for personal safety, as well as timed vertical-lifting sectional doors in the production process.

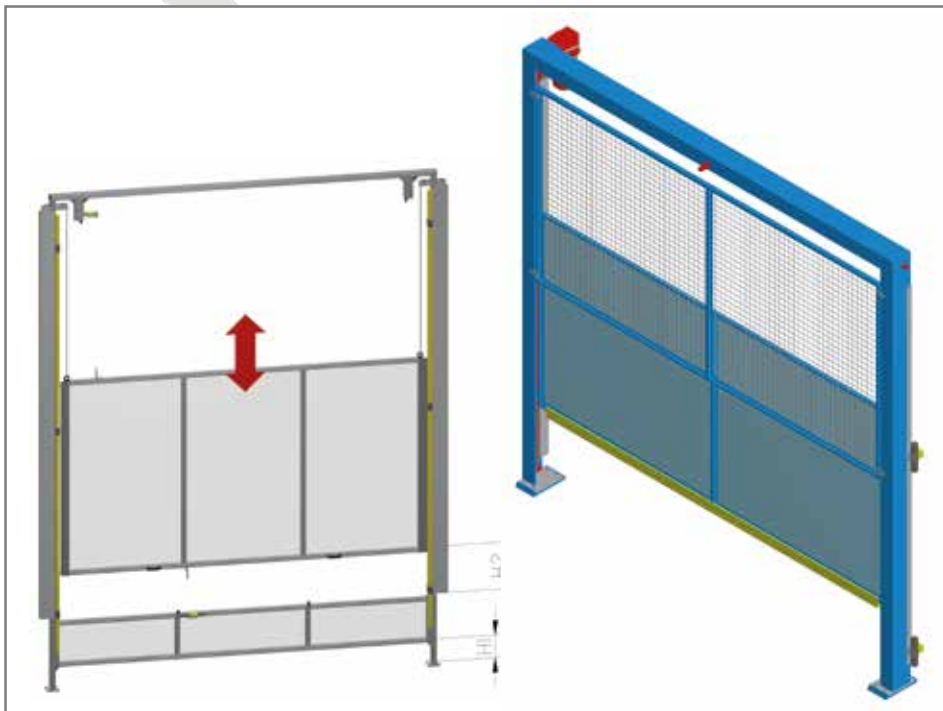

# Schiebetüren und Tore

## Sliding doors and gates

 **Fertigung** und **Montage** aus Aluminium oder Stahl. **Schiebetüren** und **Tore** eignen sich für großzügige und barrierefreie Durchgänge an Schutzzaunanlagen z. B. für Entnahme- oder Beladepunkte.

 We **manufacture** and **install sliding doors** and **gates** made of aluminum or steel. Sliding doors and gates are suitable for generous and barrier-free passages in protective fence systems, for example for removal or loading points.





# Sicherheitstüren

## Security doors

 **Fertigung** und **Montage** aus Aluminium oder Stahl. Sicherheitstüren sind als Einzel- oder Doppeltüren erhältlich und für den Einbau an Schutzgitteranlagen zum Schutz von Personen gegen das Erreichen von Gefahrstellen an Maschinen und Anlagen bestimmt. Sie können mit verschiedenen Türgriffvarianten ausgestattet werden.

 We **manufacture** and **install** security doors made of aluminum or steel. The security doors are available as single or double doors and are intended for installation in protective mesh systems to protect individuals from reaching hazardous areas on machinery and equipment. They can be equipped with various types of door handles.



# Schubladen

## Drawers

 **Fertigung** und **Montage** flexibel anpassbar, damit es den Anforderung der Produktionsanlage entspricht. Aus Aluminium oder Stahl möglich. Wenn im Fertigungsprozess Bauteile zugeführt oder ein- und ausgeschleust werden müssen, sind die Schubladen eine verlässliche Lösung.

 We **manufacture** and **install** drawers that are flexibly adaptable to meet the requirements of the production plant. They can be made from aluminum or steel. When components need to be supplied or inserted and removed in the manufacturing process, drawers are a reliable solution.



# Trägerwagen, Logistik- und Sackbahnhöfe

## Logistic terminals

 Fahrerlose Transportfahrzeuge und mobile Roboter befördern Waren zwischen verschiedenen Arbeitsbereiche. Hier kommen **Trägerwagen und Logistikbahnhöfe** zum Einsatz. Wir **fertigen** und diese Bauteile und übernehmen die **Endmontage vor Ort**.

 Automated guided vehicles (AGVs) and mobile robots transport goods between different work areas. **Carrier wagons and logistics stations** are used here. We **manufacture** these components and carry out the **final assembly on site**.

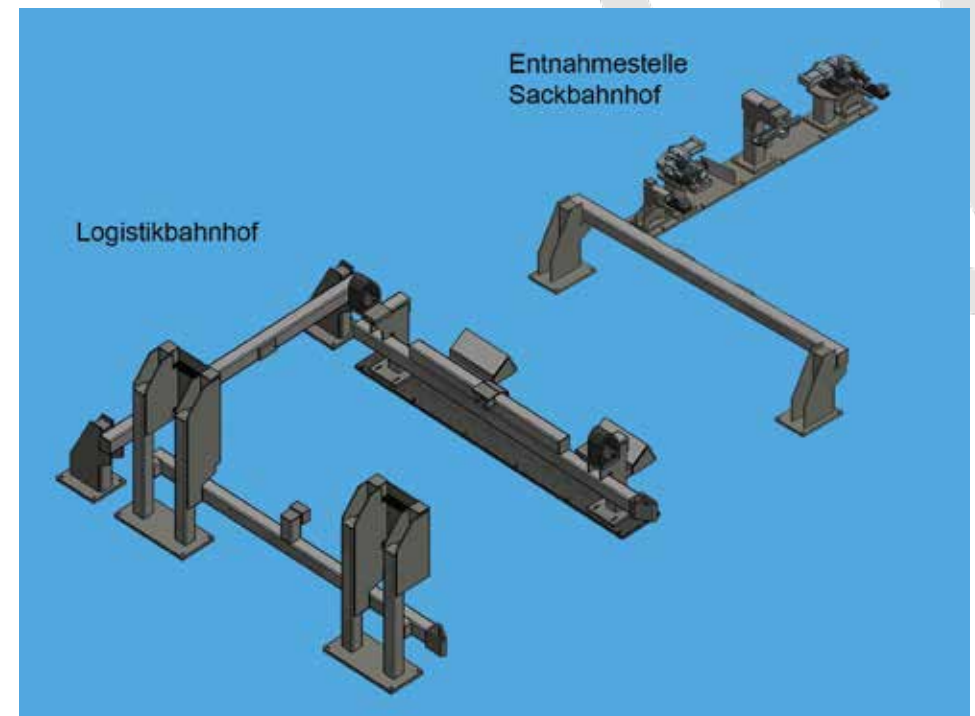

# Leitplanken

## Guardrails



**Schutzplanken** für z. B. Produktionshallen **fertigen** wir nach Kundenvorgabe und übernehmen die **Vor-Ort-Montage**.





We manufacture **safety barriers** for production halls, according to customer specifications, and take care of the **on-site installation**.



# Anfahrerschutz

## Crash protection

 Unser **Anfahrerschutz** kommt in kritischen Bereichen wie z. B. bei Ein- und Ausfahrten mit LKW- und Staplerverkehr, Ecken, Rohre usw. in Logistik- und Produktionshallen zum Einsatz. Wir **fertigen** und **montieren** diese in verschiedenen Ausführungen.

 We **manufacture** and **install** our **collision protection systems** in various designs, which are used in critical areas such as entering and exiting with truck and forklift traffic, corners, pipes, etc. in logistics and production halls.

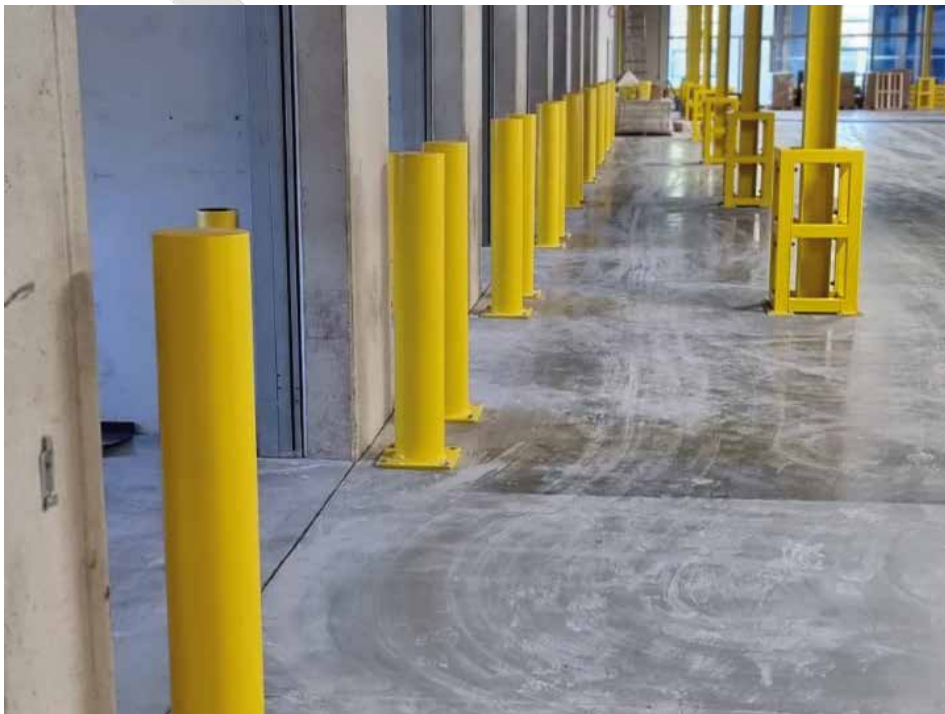

# Bodenabdeckungen und Doppelboden

## Floor coverings and raised access floors



Fertigung und Montage



Manufacturing and assembling



# Verschiedene Anlagenbauteile

## Various plant components



# Grobmontage

## Rough assembly



Wir erledigen professionell mit einem qualifizierten Team die **Grobmontage** der **kompletten Anlage** oder einzelner **Anlagenkomponenten**.



We professionally handle the rough assembly of the entire system or individual components of the system with a qualified team.





# Anlagenmontage

## Plant assembly

 **Schutzgitteranlagen, Stahlbauten,** Treppen und spezielle Vorrichtungen, als auch sämtliche von Ihnen beigestellten Bauteile, montieren wir im Rahmen der **Anlagenmontage vor Ort.**

 We assemble **protective grille systems, steel structures,** stairs and special devices, as well as all components provided by you, **on site** as part of the **system assembly.**



# Referenzen

## References



Wir verfügen über ein starkes Mitarbeiter-Team, welchem unsere Kunden vertrauen. Hier ein kleiner Auszug unserer **namhaften Kunden** aus Industrie und Handel.



We have a strong team of employees whom our customers trust. Here is a small excerpt of our **well-known customers** from industry and commerce.

DAIMLER



Audi



SIEMENS

KUKA



ABB



# Zertifizierungen

## Certifications

 Durch unsere **Unternehmenszertifikate** können wir die angewandte **Qualitätsmanagementsysteme** nachweisen. Wir können den **Schweißstandard EXC3** vorweisen. Diese können auf unserer Homepage [www.blank-mt.com](http://www.blank-mt.com) eingesehen und heruntergeladen werden.

Ein Schweißzertifikat nach **EN 1090-3, Stufe EXC3**, ist ein Qualifikationsnachweis für Schweißer und Schweißprozesse gemäß den europäischen Normen. Diese Zertifizierung zeigt, dass der Inhaber in der Lage ist, Schweißarbeiten an hochbeanspruchten Stahl- und Aluminiumkonstruktionen durchzuführen.

 Through our **company certificates**, we can demonstrate the applied **quality management systems**. We can provide evidence of the **welding standard EXC3**. These can be viewed and downloaded on our website [www.blank-mt.com](http://www.blank-mt.com).

A welding certificate according to **EN 1090-3, Level EXC3**, is a qualification proof for welders and welding processes according to European standards. This certification demonstrates that the holder is capable of performing welding work on highly stressed steel and aluminum structures.



# Kontaktinformation

## contact information

 Haben Sie ein Anliegen oder eine Frage zu unseren Produkten oder Leistungen?  
Gerne beraten wir Sie.  
Sprechen Sie uns an!

 Do you have a concern or a question  
about our products or services?

We would be happy to advise you.  
Contact us!



### **Blank Metallbau-Technik GmbH**

Max-Eyth-Str. 7-9  
71088 Holzgerlingen  
Germany

Tel.: +49 7031 73446-0  
Fax: +49 7031 73446-79

E-Mail: [info@blank-mt.com](mailto:info@blank-mt.com)  
Web: [www.blank-mt.com](http://www.blank-mt.com)

